

INSTALLATION GUIDE

INSTALLING LUMACURVE LED UPGRADE KITS

REPLACING EXISTING LIGHTING SYSTEMS (SIZES 1, 2, 3 & 5)

The purpose of this guide is to help contractors and airfield personnel install Lumacurve LED Upgrade Lighting Kits into existing Lumacurve airfield guidance signs. Work through the steps below and if you have any problems, don't hesitate to call us for technical support at 800-258-1997.

We recommend reading through the entire instructions first and familiarizing yourself with the procedures before beginning the installation.

NOTE: Using Non-OEM after-market parts will void FAA Certification and void manufacturer warranties.

WARNING: The sign must be de-energized before working on Lumacurve airfield guidance signs, unless otherwise instructed. Failure to do so may result in personal injury or damage to internal sign components.

RECOMMENDED TOOLS

- Small Standard Screwdriver
- #2 Phillips Screwdriver
- 7/16" Combination wrench
- Power Drill
- Drill Bits: 13/64", 1/4", 5/32", 1/8"
- 3/8" Socket Wrench or NutDriver
- Rubber Mallet
- Pop Rivet Tool 1/8"

1. REMOVAL OF EXISTING LIGHTING SYSTEM

- a) Remove sign tops and all panels.
- b) Unscrew power cord leads and remove from terminal strip. (Photo #1)
- c) Loosen the set screw on the strain relief clamp (Photo #2) and pull the length of the cord out of the clamp. Lay cord on bottom of sign for reconnection once LED light bars are installed.
- d) Remove all the screws that attach the light bars to the vertical sign frame components (Tools: 3/8" socket or nutdriver and #2 Phillips screwdriver).
- e) Remove the light bars from the sign.

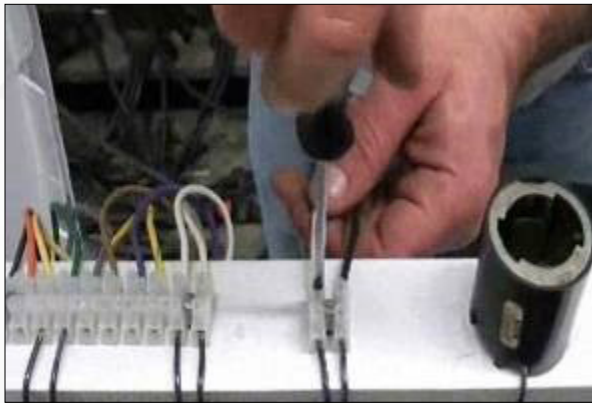

PHOTO #1



PHOTO #2

2. INSTALLING THE LED LIGHT BARS

a) Place the light bar with terminal strip and strain relief clamp into position first. The terminal strip end must be installed closest to the power cord. (Photo #3)

Note: For multiple module sign, the light bars are connected with continuous wiring. Additional modules must be fed through the tree branches to place into position. For size 2 (medium) and size 3 (large) signs, the light bars of the additional modules must pass below the center branch of the trees (Photo #4) and installed in order.

For size 1 (small) signs, pass the light bars below the bottom branch.

b) Reinstall the tops and tighten all the turn fasteners.

c) After tightening turn fasteners, take a rubber mallet and give a firm tap to the top of the end panel closest to the power cord. (Photo #5) **Note:** Reinstalling the tops properly and eliminating any gaps, prior to mounting the light bars, ensures that the sign frame is aligned and the legend panels will fit squarely (and smoothly) into the frame.

d) With the light bars in place, drill through the pilot holes of the new light bars with a 13/64" drill bit. After every drilled hole, replace the screws before drilling the next hole. (**Note:** If screws are not replaced as holes are drilled, the lightbar may move between holes. Misaligned holes cause difficulties when replacing screws.

e) Place lockwashers and nuts (or nylon nuts) on the screws on the underside of the light bars. Tighten them with a 3/8" socket or nutdriver and #2 phillips screwdriver.

Note: Tops may now be removed again to allow more light and headroom while completing the rest of the installation.



PHOTO #3

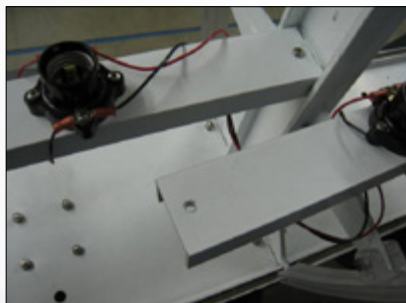

PHOTO #4



PHOTO #5

3. INSTALLING THE CONTROLLER

The Controller is to be mounted on the end panel closest to the power cord.

- a) Position the "LED Controller Mounting Hole Template" on the panel, closest to the powercord (above the lightbar). Using a 13/64" drill bit, drill two (2) mounting holes (upper left and lower right).

Warning: Do not drill through the actual mounting holes of the controller with the controller in place! There is a very high risk of doing damage to the controller.

Note: The controller needs to be a least 2" above the lightbar to keep the controller and filter screen from interfering with the surge protector (Photo #6).

- b) Remove the template. The template should be used for multiple LED Controller installations.
- c) Insert the two 10 – 24 x 1-1/4 bolts from the outside of the end panel.
- d) While holding the bolts in place, slide the controller over the bolts.

Note: Controller DC outputs must be oriented toward the top of the sign, AC inputs to the bottom.

- e) Tighten and secure controller in place using the enclosed nylon nuts.

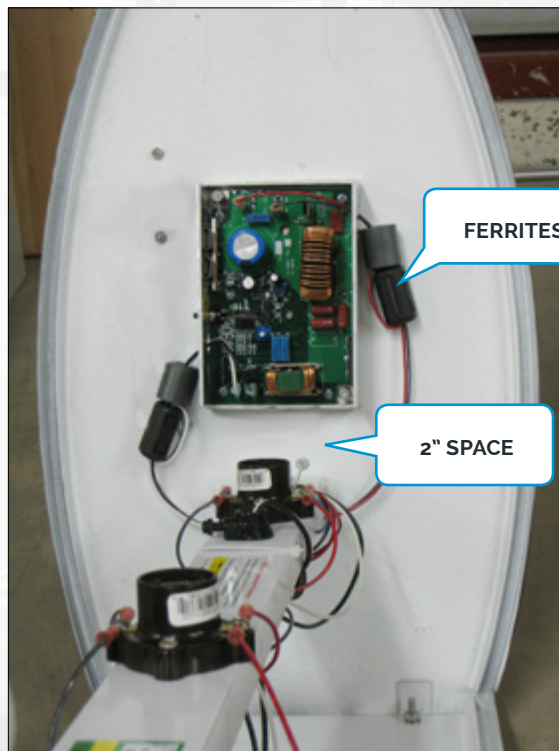

PHOTO #6

4. INSTALLING THE LINE FILTER

- a) Place the filter on the sign base (underneath the light bar) of the power leg module.
- b) Orient the wire side of the filter to face the controller. Adjust the position of the filter to be approximately 13" from the end panel. (Photo #7).
- c) Adjust the position of the filter to be approximately 2.5" from the inside edge of the sign base on one side and approximately 3" from the inside edge of the sign base on the other side (Figure #8).
Warning: Do not center the filter between the two edges of the sign base! There are two reinforcement ribs running the length of the sign base inside its double wall. Centering the filter runs the risk of drilling into the ribs.
- d) Even though the filter has four holes for mounting, only two are required to hold the filter in place. Mark two hole locations diagonally across from each other. Remove the filter, locate the marked hole locations then drill using a 5/32" drill bit. Note: the sign frame base is double-walled. Only drill through the top (interior/white) wall.
- e) Place the filter back in to place and secure using the enclosed #10-3/4" hexhead self-tapping screws.

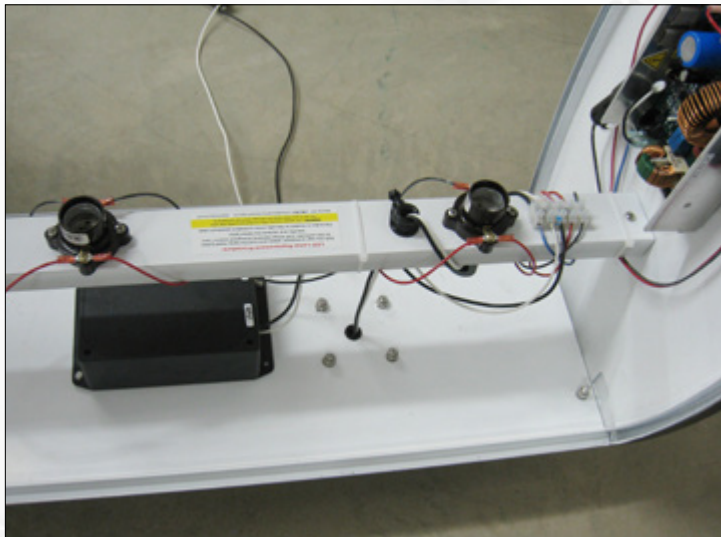

PHOTO #7

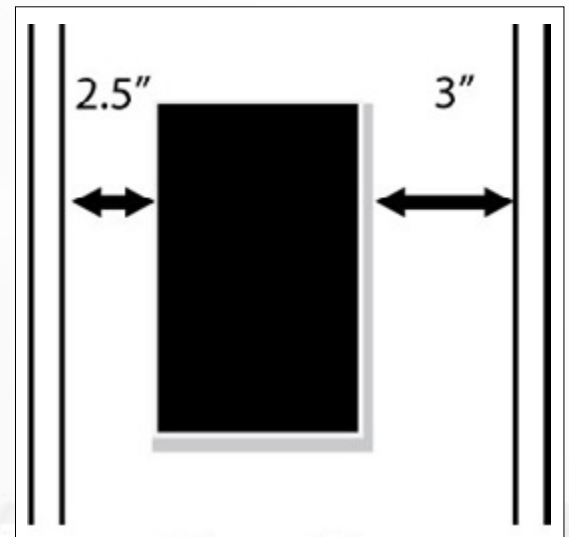

FIGURE #8

5. REINSTALLING THE POWER CORD

- a) Feed the power cord through the ferrite provided and then through the strain relief clamp (Photo #9) from the underside of the lightbar. Pull the power cord taught removing any slack between the bottom of sign and the cable clamp. As required by the FAA, this ensures the power cord will disconnect at the plug in the frangible sign leg in the event the sign is knocked over.
- b) Tighten the set screw on the strain relief cable clamp (Photo #10). Do not over tighten.
- c) Reinstall the power cord leads to first two terminals on the power strip opposite the surge protector (Figure #11). Excess slack in power cord can be trimmed to fit or coiled and zip-tied to the underside of the lightbar. This will eliminate any potential shadowing from excess wire onto the panel faces.

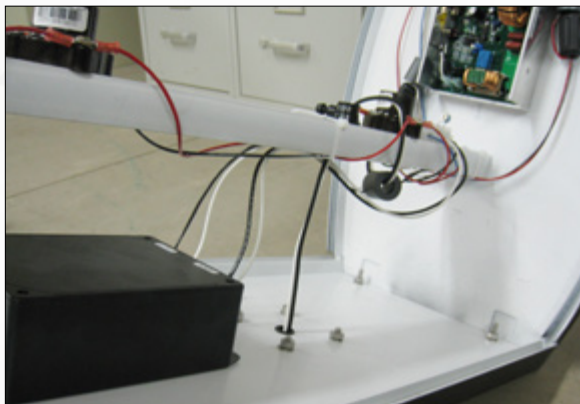

PHOTO #9



PHOTO #10

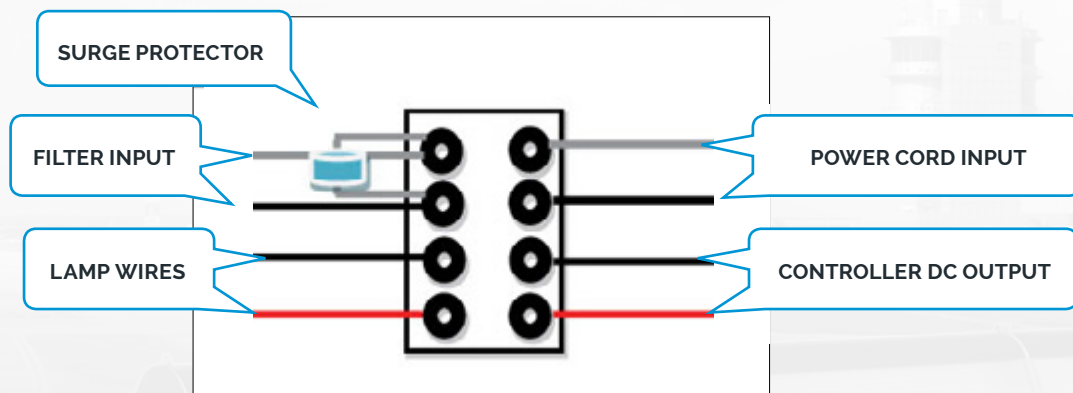

FIGURE #11

6. CONNECTING THE LINE FILTER & DC OUTPUT LEADS

- Identify the input leads from the filter. Install these black and white leads into the terminal strip opposite of the power cord leads. These leads are in parallel with surge protector (Figure #11).
- Identify the output leads from the filter. They will have 2 factory installed donut shaped black ferrites on one end. Route these leads through the hole on the lower left side of the controller (Photo #12) and connect to the AC input of the controller (Photo #13). Polarity for the AC input does not matter.
- Identify the DC output leads (Photo #14). Connect the ends without the spade connectors to the terminal strip (Figure #11). Match them with their black and red factory installed counterpart. Route the ends with the spade connectors through the hole on the upper right side of the controller (Photo #15) and connect to the DC output of the controller (Photo #15). Polarity is important: be sure to connect the red wire to the positive (+) DC output terminal and the black wire to the negative (-) DC output terminal.

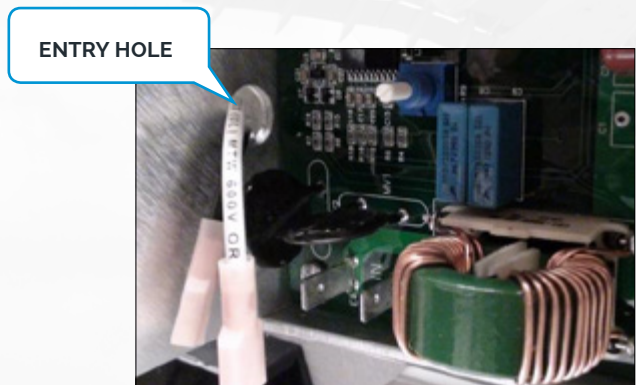

PHOTO #12

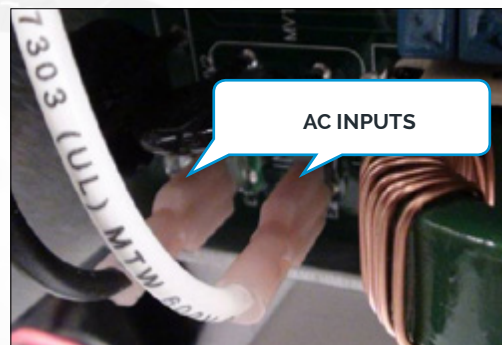

PHOTO #13

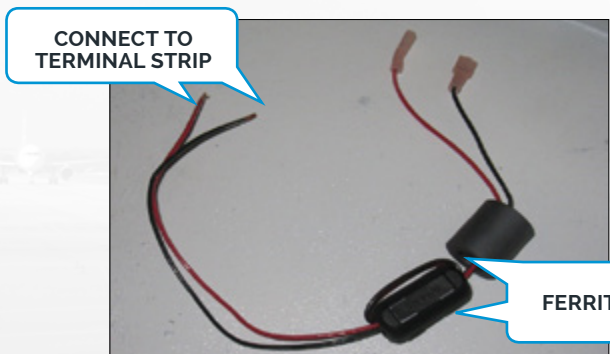

PHOTO #14

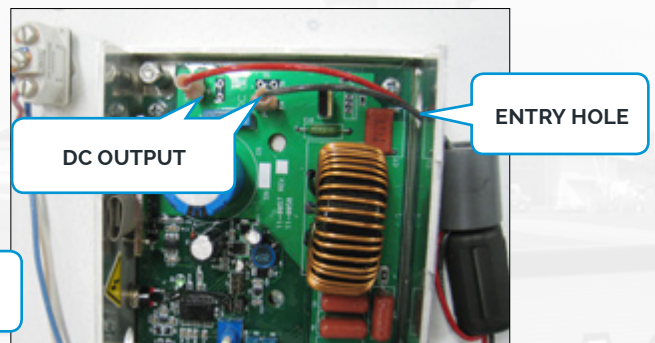
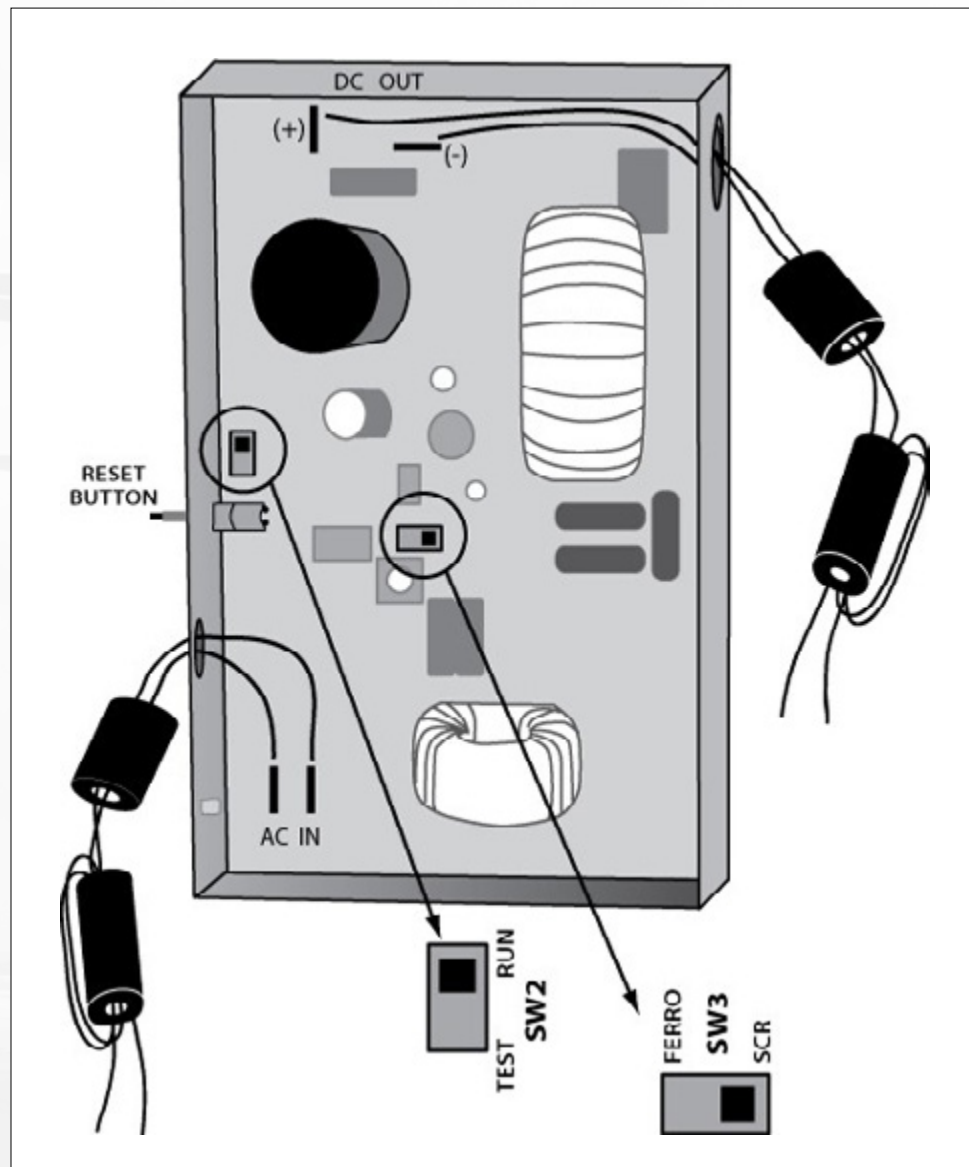

PHOTO #15

7. REVIEW THE CONTROLLER SWITCH SETTINGS

- Controller version L610-REV.07M pictured
- Switch SW2 (Run & Test) is used to isolate controller programming functions when troubleshooting (1 out all out).
- Switch SW3 (Ferro & SCR) is used to set controller functions with constant current regulators (CCR's)



L610 - REV. 07M

**JUMPER POSITION BASED ON REGULATOR TYPE FOR OLDER VERSIONS OF L610 CONTROLLERS
(DECEMBER 2014 OR OLDER VERSIONS)**

- The L-828 and L-829 Constant current regulator maintain constant amperage to the airfield circuit.
- The L-829 is an SCR type (silicone rectifier) commonly known as a solid state (electronic based) regulator. The L-828 is a ferro-resonant that uses transformer technology.
- For SCR type L-829 regulators, a jumper (photo #1) must be installed on the LED controller (as shown in figure #3 or figure #5). For ferro-resonant type L-828 regulators controller (as shown in figure #2 or figure #4).

INSTRUCTIONS FOR INSTALLING THE JUMPER:

- Identify the type of Constant Current Regulator powering this sign. ("SCR" solid state or "Ferro-Resonant" type)
- Remove shield screen by loosening the fender washers.
- Locate the small black jumper. The jumper is factory installed. (figure #2 or figure #4).
- When using SCR regulator, remove jumper for ferro-resonant regulator application and reinstall over both pins as shown in photo (figure #3 or figure #5).
- Reinstall shield screen.



PHOTO #1

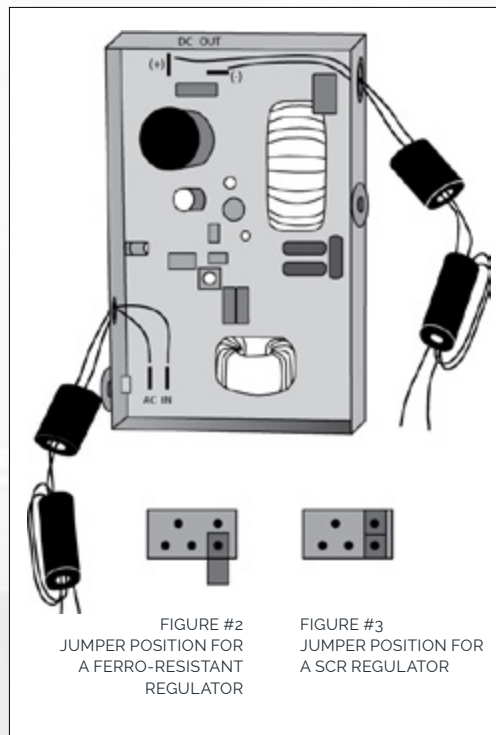

L610 - REV. 05 OR OLDER

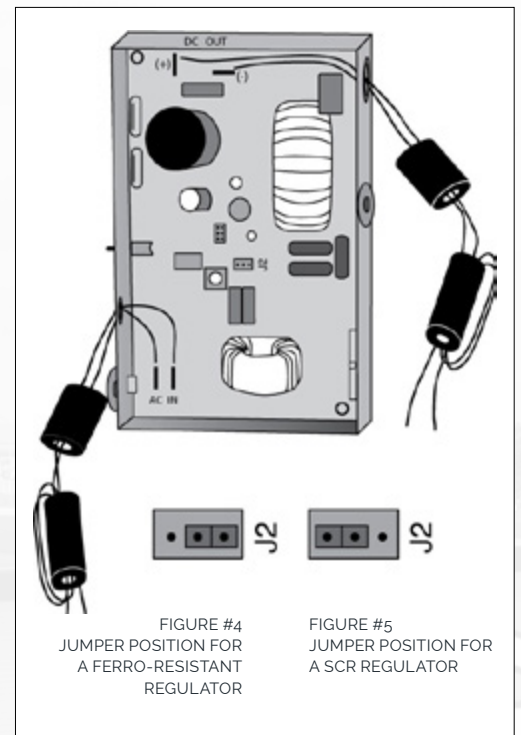

L610 - REV. 06

8. INSTALLING THE SHIELDING SCREEN

On each side of the controller are screws and fender washers (Figure #17). These hold the shielding screen in place. If the fender washers are tight to the side of the controller, loosen them slightly to slip the edge of the screen between the fender washer and the controller case. The shielding screen is shaped to precisely fit the controller. Once the screen is in place, tighten the screw & fender washers to secure screen.

9. INSTALLING THE OEM ELECTRICAL UPGRADE NAMEPLATE

Each Lumacurve LED Upgrade kit comes with an OEM upgrade nameplate (Photo #18) & (2) 1/8" pop-rivets. It is essential that the correct nameplate be installed after the electrical installation is completed. This is critical information for the future maintenance of the sign. With the exception of size one (small) LOVA & XTL signs, the nameplate should be mounted just below the original factory nameplate.

- a) Identify the correct nameplate with the accurate sign number & catalog number for the power kit installed.
- b) Identify a location to mount the nameplate on the end panel (power leg end). Be sure it is clear of any electrical components that may be mounted on the inside of the end panel. In most situations, just below the original factory nameplate is recommended.
- c) While holding the nameplate in place, drill through the holes with a 1/8" or 9/64" drill bit.
- d) Install the 1/8" pop-rivets securing the nameplate in place.



10. CHECKING SYSTEM & RESTORING THE SIGN TO SERVICE

All the electrical components should now be mounted and wired properly.

a) Insert all lamps into the sockets.

Warning: the use of non-OEM replacement lamps may damage electrical components and cause premature lamp failure. Only OEM Lumacurve lamps will maintain FAA photometric requirement and factory warranties.

b) Check that the properly sized isolation transformer is being used. See chart.

c) Signs powered by L-828 SCR regulators (solid state) must have jumper in place on the controller. (see step #7)

d) Power up sign and check that all lamps are functioning properly.

Note: If sign is not functioning, revisit above steps once again to ensure the sign is wired properly. If there are still problems, contact us for technical support at 800-258-1997.

e) Reinstall all the legend panels. Replace and secure all sign tops.

Use the chart below to identify the proper size isolation transformer.

SIGN & SIZE			LED LIGHTING SYSTEMS								
			FAA STYLE 2 (4.8A-6.6A), 4W LED			FAA STYLE 3 (2.8A-6.6A), 4W LED			FAA STYLE 5 (5.5A), 4W LED		
MODULE	LENGTH	LAMPS	ISOL XFMR	MAX VA	PWR FACTR	ISOL XFMR	MAX VA	PWR FACTR	ISOL XFMR	MAX VA	PWR FACTR
SIZE 1	1-MOD	2	45W	47	0.93	45W	47	0.93	45W	37	0.94
	2-MOD	4	100W	59	0.88	100W	58	0.88	100W	47	0.91
	3-MOD	6	100W	66	0.90	100W	66	0.90	100W	54	0.93
	4-MOD	8	100W	73	0.92	100W	72	0.92	100W	61	0.94
SIZE 2	1-MOD	3	100W	57	0.87	100W	56	0.87	100W	44	0.89
	2-MOD	6	100W	66	0.90	100W	66	0.90	100W	54	0.93
	3-MOD	9	100W	76	0.92	100W	76	0.92	100W	64	0.94
	4-MOD	12	100W	86	0.94	100W	86	0.94	100W	75	0.96
SIZE 3	1-MOD	3	100W	57	0.87	100W	56	0.87	100W	44	0.89
	2-MOD	6	100w	66	0.90	100w	66	0.90	100w	54	0.93
	3-MOD	9	100w	76	0.92	100w	76	0.92	100w	64	0.94
	4-MOD	12	100w	86	0.94	100w	86	0.94	100w	75	0.96
SIZE 5	1-MOD	3	100w	57	0.87	100w	56	0.87	100w	44	0.89
SIZE 4	1-MOD	6	100w	66	0.90	100w	66	0.90	100w	54	0.93